

# USER GUIDE

# BM500

## BATTERY MONITOR & SHUNT



# CONTENTS

<b>1.</b>	<b>Product Overview</b>	<b>3</b>
	Overview	3
	Key Features	3
	Package Contents	3
	Display Panel	4
<b>2.</b>	<b>Operation</b>	<b>5</b>
	Installation	5
	Battery Connection	6
	Parallel Battery Connection	6
	Series Battery Connection	6
	Battery Monitor & Setup	7
	Fault Codes & Trouble Shooting	8
<b>3.</b>	<b>Specifications</b>	<b>8</b>
	Dimensions	9
<b>4.</b>	<b>Safety Precautions</b>	<b>10</b>
<b>5.</b>	<b>Contact Us</b>	<b>Back Page</b>

# OVERVIEW







Take control of your battery system with the iTechworld BM500 Battery Monitor and Shunt. Designed and developed here in Australia for precision and reliability, this advanced monitoring system delivers a real time overview into your battery's performance, including discharge and charge currents, Amp Hour (Ah), and voltage. It also features visual and audible alarms to notify you of unexpected voltage drops, helping you avoid power outages. With a robust 500 amp shunt, the BM500 ensures accurate readings on even the larger battery systems for lithium and lead acid battery types.

Whether you're powering a caravan, camper, boat, 4WD, or even an off grid system, the iTechworld BM500 provides reliable and precise battery monitoring, giving you confidence and control over your battery system power usage.

## KEY FEATURES

- Easy to use LCD display
- Accurate readings to the nearest percentage
- Adjustable screen brightness
- Audible and visual low voltage alarm
- Built in 500A shunt
- Suitable for iTechworld lithium and all lead acid batteries
- Cross polarity, over voltage, under voltage, and over current protection

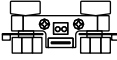
## Package Contents

 <p>Battery Monitor</p>	 <p>Bracket</p>	 <p>3m shielded wire</p>	 <p>1m sense wire</p>	 <p>500A shunt</p>	 <p>Screws</p>
--	--	---	--	---	--

## DISPLAY PANEL

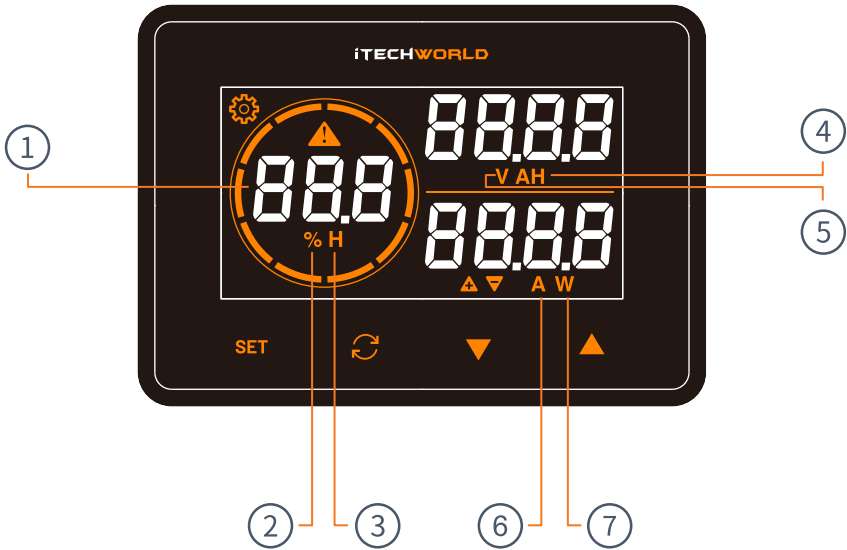

① STATE OF CHARGE

② PERCENTAGE

③ TIME REMAINING

④ Ah REMAINING

⑤ VOLTAGE

⑥ AMPERAGE

⑦ WATTAGE

# OPERATION

## INSTALLATION

1. Choose a flat and stable surface for installation, ensuring the unit can easily be accessed.
2. Insert the monitor into the included bracket.
3. Position and level the unit, then drill holes in your mounting surface.
4. Secure the unit using 4 x M4 screws, tightening the screws with a manual screwdriver, being sure not to over tighten.

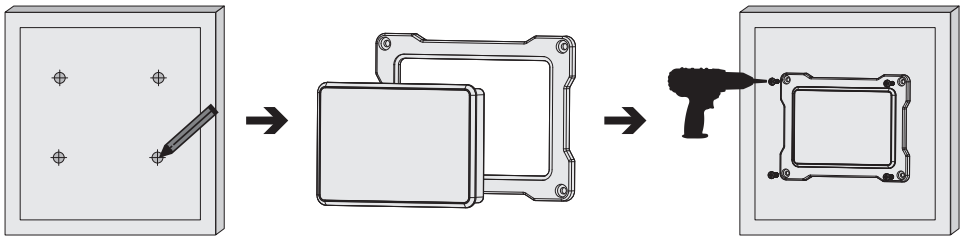

5. To remove the monitor from the bracket, press the clips on the top and bottom of the monitor at the same time, it can then be removed.

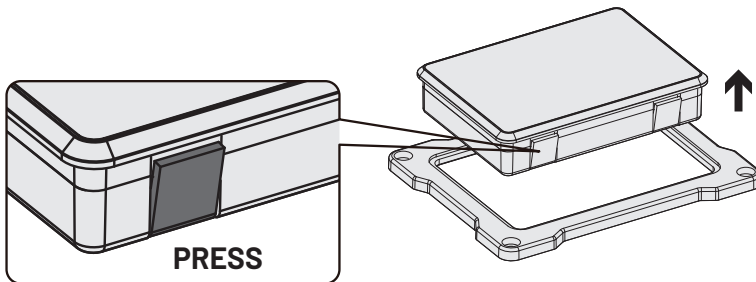

**Note:** All the negative loads and chargers, need to be connected to the P - side of the shunt for correct battery monitor readings. If multiple negatives connect directly to the battery, it means the shunt has been installed incorrectly, the B - side of the shunt should be the only negative connection. Excluding series or parallel connections.

## BATTERY CONNECTION

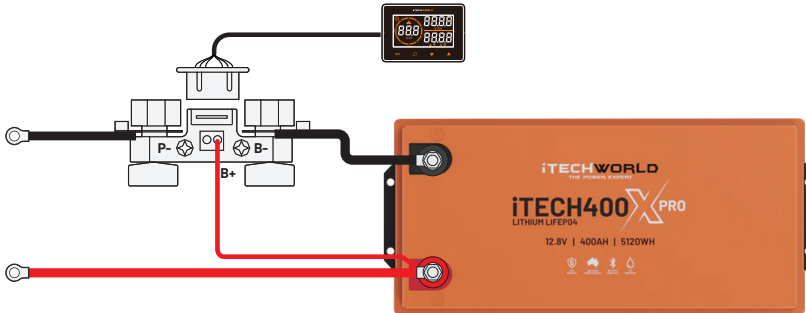

## PARALLEL BATTERY CONNECTION

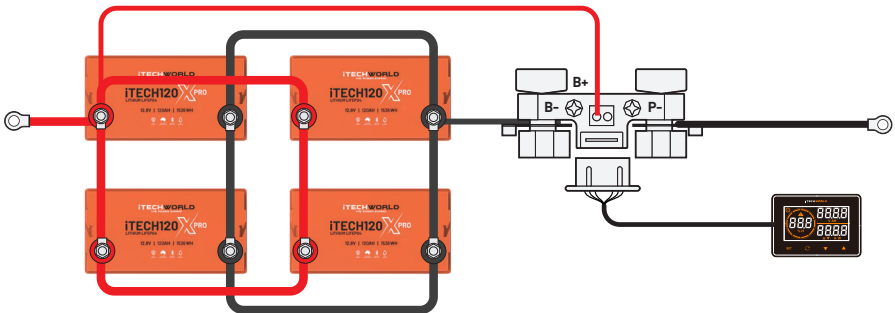

## SERIES BATTERY CONNECTION

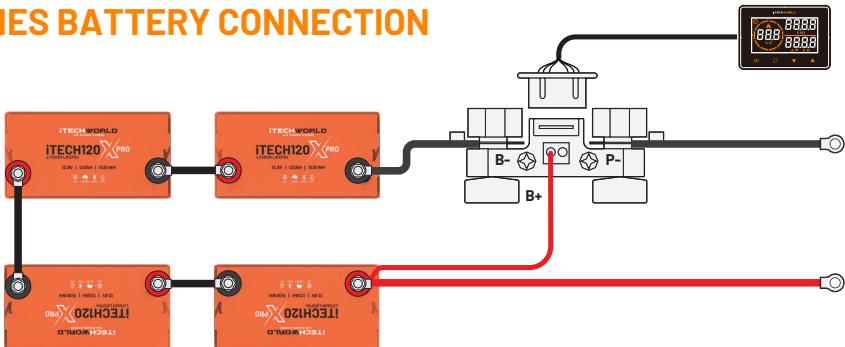

## BATTERY MONITOR & SETUP

1. Enter the settings screen by pressing and holding the SET button.
2. Enter the SET1 interface to set the overvoltage value and adjust through the up and down arrows. This value should be 0.5V above the battery's stated maximum voltage to allow for a higher float charge voltage.
3. After setting the overvoltage value, short press the SET button to enter the SET2 interface for the undervoltage settings. As before, adjust the values with the up and down arrows. This value represents the voltage at 0% capacity. Please be aware that this number will vary depending on battery type. Recommended settings for lithium batteries are as follows:
  - Lithium: 10.5V
4. After setting the undervoltage value, short press the SET button to enter the SET3 interface for overcurrent settings. You must match this value with the battery's rated maximum current.
5. After setting the overcurrent value, short press the SET button to enter the SET4 interface for capacity settings. Set this value according to the actual capacity of the connected battery.
6. After setting the capacity, short press the SET button to enter the SET5 interface for percentage settings. Set the current battery percentage to 100%.

**Note:** We recommend charging your lithium battery to 13.5V before setting your battery monitor to 100%.

7. After setting the percentage value, short press the SET button to enter the SET6 interface for backlight brightness settings. Set this value to your preferred brightness.
8. After setting the backlight brightness, short or long press the SET button to exit the setting interface and return to the home screen.

## FAULT CODES & TROUBLE SHOOTING

Fault Code	Fault	Solution
F1	Over Voltage	Isolate the monitor for 60 seconds. Ensure the input voltage is below the overvoltage value applied in the SET1 interface.
F2	Under Voltage	Isolate the monitor for 60 seconds. Ensure the input voltage is above the undervoltage value applied in the SET2 interface.
F3	Over Current	Isolate the monitor for 60 seconds. Ensure the current does not exceed the overcurrent value applied in SET3.

## SPECIFICATIONS

Battery Monitor	
Model	iTECHBM500
Supply Voltage	10V-100V
Battery Capacity	10Ah-999Ah
Maximum Measured Current	500A
Power Consumption (Screen Off)	<2mA
Power Consumption (Screen Brightness @ 10%)	<20mA
Power Consumption (Screen Brightness @ 100%)	<60mA
Voltage Accuracy	±1%
Current Accuracy	±1%
Capacity Accuracy	±1%
Operating Temperature	-20°C ~ 80°C
Exterior bracket dimensions (LxWxH)	106 x 81 x 18mm
Mounting bracket points (LxW)	95 x 70mm
Monitor backing dimensions (LxWxH)	80 x 59 x 16mm
IP Rating	IP20



# DIMENSIONS

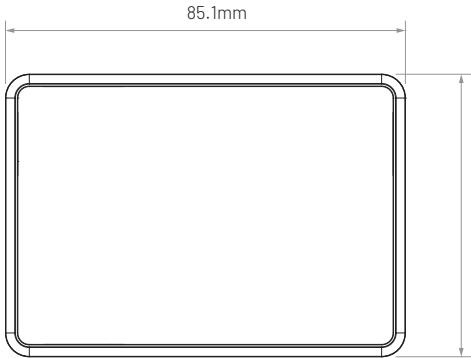
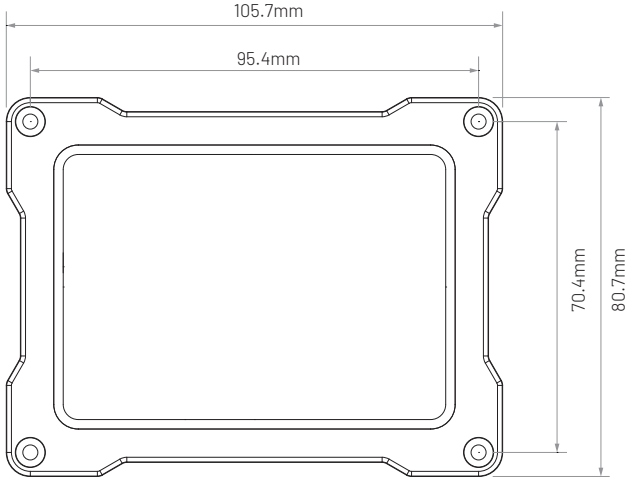

# SAFETY PRECAUTIONS

The BM500 battery monitor and shunt must be installed and operated correctly for safe operation and optimal performance. Please carefully read, understand and follow all instructions and guidelines in this user guide. Failure to follow these instructions may result in damage to the unit or property, death or serious injury.

**Disclaimer:** While iTechworld has taken every precaution to ensure the accuracy of the contents of this user guide, iTechworld assumes no responsibility for any errors or omissions.

**Furthermore, all specifications and functionality may change at any time without notice.**

It is best to view our website for the most up-to date information

**WARNING:**

Never insert anything other than a compatible adapter into any of the ports on the battery monitor or shunt.

**WARNING:**

People with physical disabilities, visual, sensory, or mental impairments (including children) should not use this device. Children should be supervised to ensure they do not play with the device.

**WARNING:**

Do not drop your battery monitor or shunt.

**WARNING:**

Ensure the battery monitor or shunt does not come into contact with water, rain or snow. Failure to do so may lead to permanent damage to the internal electronics and will void the warranty.

**WARNING:**

Do not use your battery monitor or shunt to connect equipment if there is a defect.

**DANGER:**

Do not modify the battery monitor or shunt. Doing so may result in a risk of electrical shock, fire death, or serious injury.

**LIMITATIONS OF USE:**

Do not use in connection with life support systems or other medical devices.

# iTECHWORLD

THE POWER EXPERT

## CONTACT US



1300 483 249



service@itechworld.com.au



www.itechworld.com.au



When it comes to energy storage and creation at iTechworld, we take pride in being one of the biggest names in the industry. Based in Australia, we are a family-owned and operated business. With many more innovative products on the horizon we are committed to constantly raising the bar to provide bigger and better benefits to all our customers Australia-wide.

Whether you're an avid camper, 4WD enthusiast, freedom seeker or camper, we've got your power needs covered. Escape the grid without compromise, minimise your downtime and travel with comfort with our large range of leading products at great prices.

**iTechworld. The Power Expert.**

## LOVE YOUR BM500? LEAVE A REVIEW

